



Diffuse Ref. Photoelectric Sensors



PHOTOELECTRIC SENSORS IN PLASTIC HOUSING 24 ÷ 230 V AC TRIAC NC OUTPUT

- Short housing
- Leakage < 1.5 mA @ 220 V AC
- Models w/o pots for simple installation
- Cable or M12 quick connect models
- Models with 9-turn pot

18 Series



Identification code

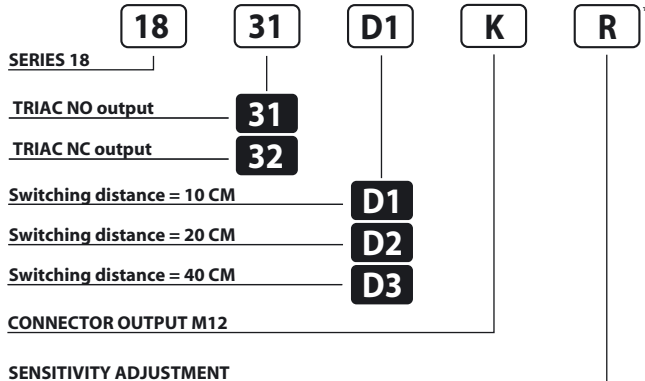

"K" and "R" not available in the same model.
 * "R" available only for D2 and D3 models.

AVAILABLE	D1	D2	D3
NOMINAL SWITCHING DISTANCE (Sn)	10 cm ⁽¹⁾	20 cm ⁽¹⁾	40 cm ⁽¹⁾
TOLERANCE	+10/-10 %Sn		
HYSTERESIS	10%		
EMISSION	Infrared (875 nm)		
NOMINAL VOLTAGE	24 ÷ 230VAC (-15 /+10%)		
MAINS FREQUENCY	50 ÷ 60 Hz		
MAX. OUTPUT CURRENT	150 mA		
LEAKAGE CURRENT	≤ 1.5mA (at 220VAC)		
ABSORPTION	1 W		
VOLTAGE DROP (Sensor ON)	< 2.5 V		
OPERATION LED	Yellow		
SWITCHING FREQUENCY	10 Hz		
RESPONSE TIME	100 mS		
START UP DELAY	300 mS		
ELECTRIC PROTECTIONS	Against inductive loads		
TEMPERATURE LIMITS	-10 ÷ +60 °C		
LIGHT IMMUNITY	5000 Lux ⁽²⁾		
PROTECTION DEGREE	IP 67 (IP 65 for models with sensitivity adjustment)		
CABLE LENGTH	2 m		
CABLE SECTION	3 x 0.35 mm ²		
HOUSING MATERIAL	Housing: nylon loaded with fiberglass - Lenses: methacrylate		
WEIGHT - cable output -	120 g		

⁽¹⁾ Determined with a white mat paper (cm 10 x 10).

⁽²⁾ Determined with halogen tungsten lamp 3000 °K.

Note: for a proper use see norms at pages 12, 13, 14, 15 and 16.

Dimensions (mm)

Configuration with cable

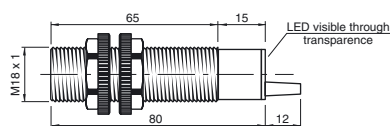

Configuration with cable - Back view

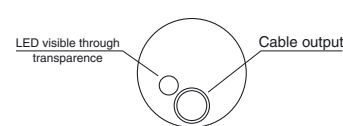

Configuration with connector K (metal housing)

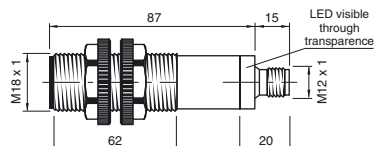

Configuration with sensitivity adjustment

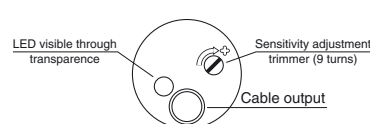

Wiring diagrams

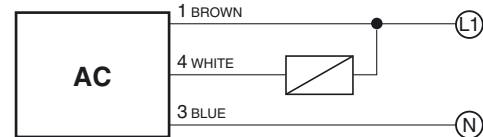

WARNING: Short circuit in the output is not possible. Wrong supply cable connections can irreparably damage the detector. Therefore sensors whose output status is short-circuited will not be substituted under warranty.

CONNECTIONS IN PARALLEL

In parallel connections with multiple outputs, the maximum leakage current (< 1,5 mA at 220 VAC) referring to the load and the supply should be taken into account when calculating the max. quantity of connectable sensors.

It is important in this connection that the sensors are connected at the same phase.

Accessories

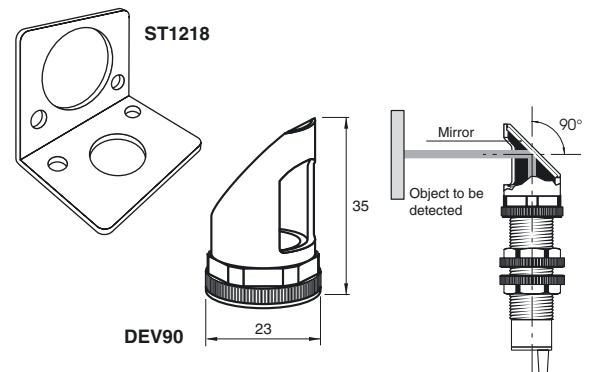

Characteristic curves

