

REFLECTORS CODES AND DIMENSIONS

- High performances
- Round models
- Rectangular models

CT Series



Rectangular type (Art. CT05)

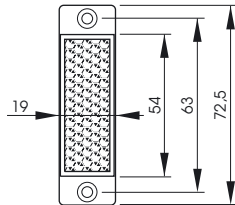

Thickness: 8,4 mm
Weight 10 g

Rectangular type (Art. CT07)

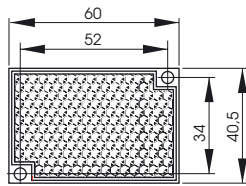

Thickness: 8 mm
Weight 10 g

Rectangular type (Art. CT100)

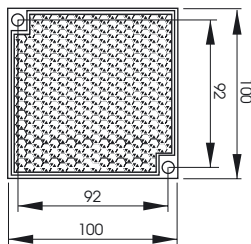

Thickness: 9 mm
Weight 40 g

Rectangular type (Art. CT150)

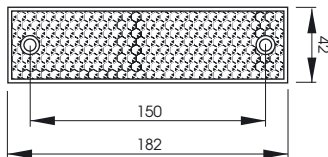

Thickness: 7,4 mm
Weight 30 g

Adhesive type (Art. CT08B)

CT08BRT
914 mm x 1000 mm sheet

NOTE: Models CT08B and CT08BRT are suitable for Polarised photocells.

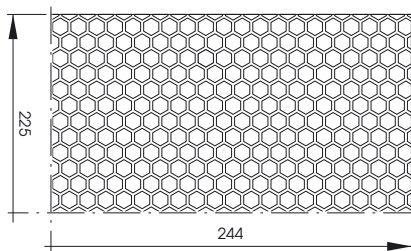

Thickness: 1 mm
Weight 32 g

The reflection distance for all models is referred to CT04S as 100%. When other models or reflectors are used, the distance results different. See the picture.

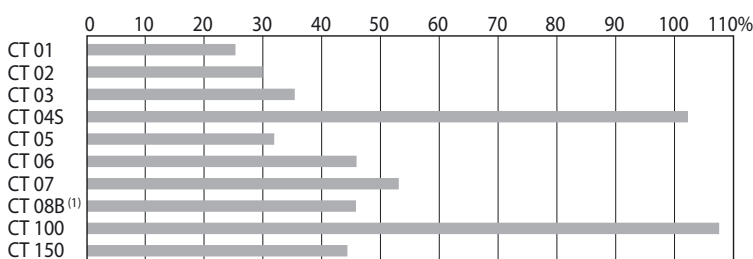

Note: ⁽¹⁾ 80 x 80 mm

Round type (Art. CT01)

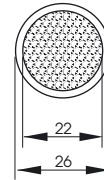

Thickness: 5 mm
Weight 1 g

Round type (Art. CT02)

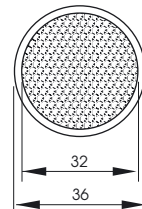

Thickness: 5.5 mm
Weight 4 g

Round type (Art. CT03)

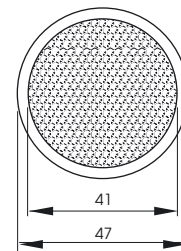

Thickness: 5 mm
Weight 1 g

Round type with fixing holes type (Art. CT04S)

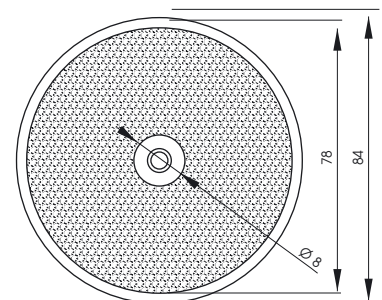

Thickness: 8 mm
Weight 25 g

Round type with fixing holes type (Art. CT06)

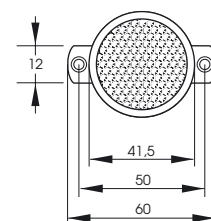

Thickness: 6,5 mm
Weight 6 g