

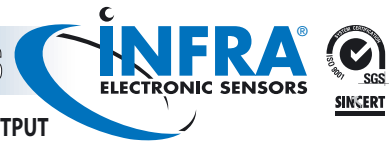

Thru Beam Photoelectric Sensors



PHOTOELECTRIC SENSORS IN SQUARE HOUSING 12 ÷ 30V DC PROGRAMMABLE OUTPUT

- Compact size, output and stability indicators
- Cost effective
- Cable or M12 quick connect models
- Fast response time: 5 mS

FQ Series



Identification code

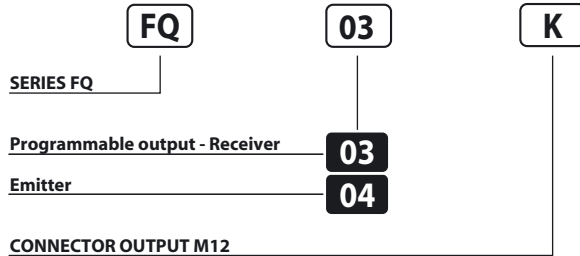

Wiring diagrams

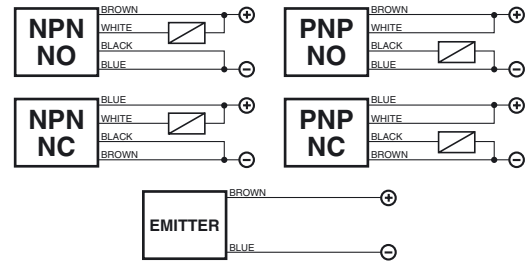

AVAILABLE	RECEIVER	EMITTER
NOMINAL SWITCHING DISTANCE (Sn)	20 m	
TOLERANCE	+10/-10 %Sn	
HYSTERESIS	10%	
EMISSION	-	Infrared (875 nm)
NOMINAL VOLTAGE	12 ÷ 30VDC (-15 /+10%)	
RESIDUAL RIPPLE	≤ 10%	
OUTPUT	NPN or PNP (programmable)	-
CONTACT	NO or NC (programmable)	-
MAX. OUTPUT CURRENT	200 mA	-
ABSORPTION AT 30 VDC	25 mA	
VOLTAGE DROP (Sensor ON)	≤ 1.8 V (I = 100 mA)	-
YELLOW LED	Output indicator	-
GREEN LED	Stability indicator	Supply indicator
SENSITIVITY ADJUSTMENT	Trimmer 1 turn	-
SWITCHING FREQUENCY	200 Hz	
RESPONSE TIME	5 mS	
START UP DELAY	100 mS	
SHORT CIRCUIT PROTECTION	Present (self-resetting)	
ELECTRIC PROTECTIONS	Against polarity reversal - inductive loads	
TEMPERATURE LIMITS	-10 + +60 °C	
LIGHT IMMUNITY	> 10.000 Lux ⁽¹⁾	
PROTECTION DEGREE	IP 65	
CABLE LENGTH	2 m	
CABLE SECTION	4 x 0.25 mm ²	2 x 0.25 mm ²
HOUSING MATERIAL	Housing: ABS - Lenses: methacrylate	
WEIGHT - cable output - (connector output)	- 160 g -	(120 g)

Connection with connector M12 (K)

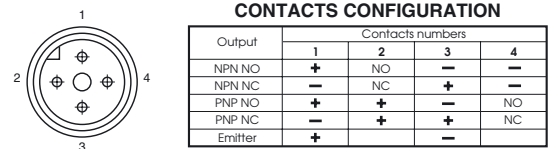

View of quadripole male connector.

Note: Photoelectric sensor not suitable for use with 90° connectors.

Sensitivity adjustment

- 1) SENSITIVITY INCREASE**
Screw the trimmer towards right towards position "+"
- 2) SENSITIVITY DECREASE**
Screw the trimmer towards left towards position "-"

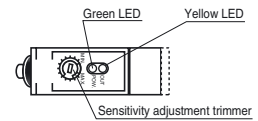

Note: the trimmer just needs one turn.

Stability signal led

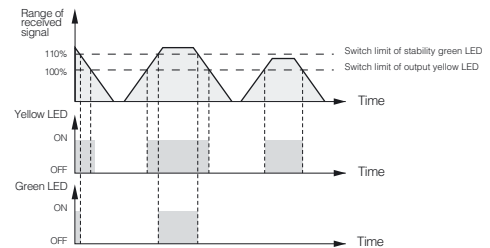

The stability signal LED shows the range of received signal and helps the photoelectric sensor to line up. A photoelectric sensor works in "stability" condition when the received light signal range is 10% ahead the switching limit of output.

Dimensions (mm)

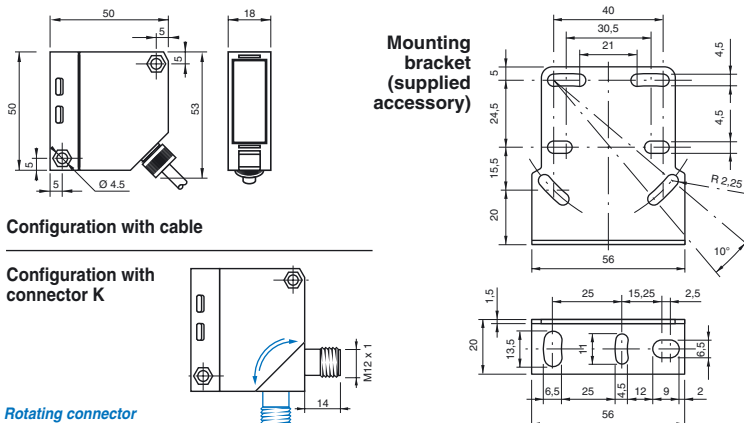

Characteristic curves

EMITTER RECEIVER THRU BEAM

